

# TRANSMITTING GPS AS TEXT FORM THROUGH WIRELESS ON DRONE 2.0

*By* Aris Pujud Kurniawan

## TRANSMITTING GPS AS TEXT FORM THROUGH WIRELESS ON DRONE 2.0

Aris Pujud Kurniawan, Giva Andriana Mutiara\*,  
Gita Indah Hapsari

Applied Science School, Computer Engineering,  
Telkom University, Bandung, West Java, Indonesia

### Article history

Received  
2 July 2015  
Received in revised form  
6 November 2015  
Accepted  
7 March 2016

\*Corresponding author  
giva.andriana@tass.telkomuniversity.ac.id

### Graphical abstract

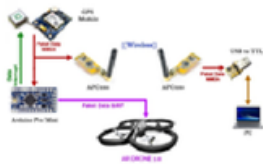

### Abstract

AR Drone 2.0 is a miniature unmanned aerial vehicle used in the field of research. AR Drone 2.0 has a camera and IMU sensors, so it can be used to get visual data from air which hardly done by human. Unmanned aerial vehicle requires GPS (Global Positioning System) so that the pilot can control it remotely as well as to support automatic fly without pilot. While GPS data are supported by AR Drone 2.0 it still needs data conversion process due to the difference in data protocol which is used between the Drone and the GPS. This conversion process required processor or controller to process the data. Integration of GPS with AR Drone using controller also allows drone to run for automatic control. In addition, GPS data will also be sent information of latitude and longitude to computer so that the pilot can determine the current position when AR Drone is flying. The GPS system used for this design can be developed further in the future because it is open source.

Keywords: AR Drone 2.0, GPS, latitude, longitude, NMEA protocol, SiRF protocol, unmanned aerial vehicle

© 2016 Penerbit UTM Press. All rights reserved

## 1.0 INTRODUCTION

Unmanned aircraft or Drone is a new technology that currently growing rapidly in the world. Drone is widely developed in the military, mapping, research, photography and others fields. The main advantage of this technology is that it can be used in dangerous places and mission without harm the pilot. Drone currently divided into two categories, the fixed wings (unmanned aircraft that uses wings) and multi rotor (drone that use more than one motor and without wings – more like a helicopter).

AR Drone 2.0 is a miniature quad core category which has four motors to rotate the propeller at each end that can generate lift force. AR Drone 2.0 can perform takeoff and landing vertically so it can be used in a narrow area. This drone can fly up to a height of 100 meters but it will look very small in that altitude, which make it difficult to be controlled and monitored its position using manual observation. Based on these problems, the practical used of this

drone will require the help of Global Positioning System (GPS) in order to know the position of the aircraft. For this implementation, it is a necessary for sending data from the GPS information to the base station or ground station to do the GPS data processing to obtained data that can provide information about its flight position. Some journals that have been studied to support this research is to study how the tracking system GPS module with monitoring via Google map[1], learn the topic of research on the development of GPS up to 10 years in the future[2] and also the study the NMEA data conversion and SiRF.

## 2.0 BASIC THEORY

### 2.1 Ar Drone 2.0

AR Drone 2.0 is a new version of quad copter produced by Parrot. It has new pressure sensors that

can make it vertically steady to a certain height and *ultrasound sensors* to stabilize its movement at altitude of less than 6 meters. In addition, there is also an IMU sensor that consists of *a3-axis gyro sensor, 3-axis accelerometer sensor and 3-axis magne to meter sensor*. Figure 1 shows the AR Drone 2.0. AR Drone 2.0 also equipped with 720p HD resolution camera with 30 fps which is installed on board. AR Drone 2.0 version can also be controlled using the smartphones based application on Android and iOS and has an API which is open source so it more open to developed [3].



Figure 1 AR DRONE 2.0

The specifications of the AR Drone 2.0 are as follows:

1. 1 GHz 32-bit ARM Cortex A8 processor with an 800MHz DSP TMS320DMC64x video.
2. Linux 2.6.32.
3. 1 G bit DDR2 RAM at 200MHz.
4. High speed USB 2.0 for extension.
5. Wi-Fi b, g, n.
6. IMU Sensor (3-axis gyroscope of 2000° / second precision, 3-axis accelerometer  $\pm 50$ mg precision, 3-axis magnetometer 6° precision).
7. Pressure sensor  $\pm 10$  Pa precision.
8. Camera 720p HD onboard. [4]

## 2.2 Arduino

Arduino is an open source microcontroller board developed by the Arduino company, Italy as been shown in Figure 2. It has input and output (I / O) channel for processing language implementation ([www.processing.org](http://www.processing.org)). [5] Arduino ProMini is one type of small and inexpensive board, which is suitable for small application that require a microcontroller.



Figure 2 Arduino Mini

## 2.3 GPS

GPS (Global Positioning System) is a satellite navigation system to locate the position of the earth (Figure 3). GPS system utilizes satellites that are in orbits, the satellite which emits a signal to the earth will be caught and processed by the GPS module. One example of the GPS module is a U-Blox GPS NEO-6M [6].



Figure 3 GPS Module

## 2.4 NMEA Protocol

NMEA (National Marine Electronics Association) protocol is a standard protocol of data in the navigation system. NMEA protocol is used on the GPS system in the delivery of data from satellites. NMEA has some header data packets with different information. Table 1 shows the header NMEA data packet.

Table 1 Header NMEA Data Packet

Header	Description
GGA	Time, position and fix type data.
GLL	Latitude, longitude, UTC time of position fix and status.
GSA	GPS receiver operating mode, satelits used in the position solution, and DOP values.
GSV	The number of GPS satelits in view satelit ID numbers, elevation, azimuth, and SNR values.
MSS	Signal-to-noise ratio, signal strength, frequency, and bit rate from a radio-beacon receiver.
RMC	Time, date, position, course and speed
VTG	Course and speed information relative to the ground.
ZDA	PPS timing message (synchronized to PPS).
150	OK to send message. [8]

## 2.5 Visual Studio

Microsoft Visual Studio is a kind of software that can be used to develop applications that run on the Windows operating system. Microsoft Visual Studio has a compiler that has several kinds of components such as Visual C++, Visual C#, Visual Basic, Visual Basic. NET, Visual Inter Dev, Visual J++, Visual J#, Visual Fox Pro, Visual Source Safe. In addition,

Microsoft Visual Studio also supports other programming languages such as Python, Ruby, XML/XSLT, HTML/XHTML, JavaScript, CSS.

**2.6 Parsing Data**

Parsing data is a method that is used to read data from a protocol packet NMEA. In outlining a package of data, there are three important components in the composition of the data packets:

1. Header, for orders or indicators address of the data presented.
2. Data, values that have information that can be processed.
3. Checksum, final part of a packet of data that will indicate the completeness of the data.[8]

**3.0 DESIGN SYSTEM**

**3.1 System Design**

Figure 4 shows the system design for sending information from the AR Drone to Ground Station. The user will control the drone and drone will send the current position. Data that are sent by the drone are the data that contains information about the position of the drone, such as latitude, longitude, speed, and others.



**Figure 4** System Block Diagram

Figure 5 and 6 shows the flow of programming algorithms for desktop application. GPS will perform initialization of data, and then system read the data NMEA Protocol, do the parsing data, converting data and sending data to AR Drone. So, AR Drone would fly to the destination.

While the user need information about the position of the drone, the system will do setting serial port and read data NMEA, then parsing data, and checking the header. After conversion the data, system will give the information about the position of the drone.

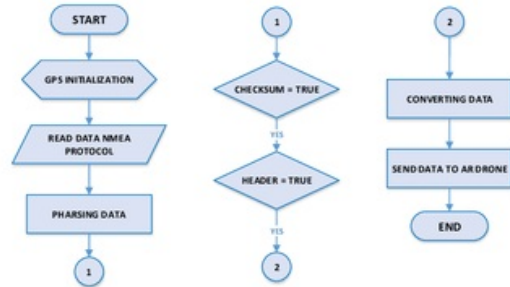

**Figure 5** Microcontroller Programming flowchart

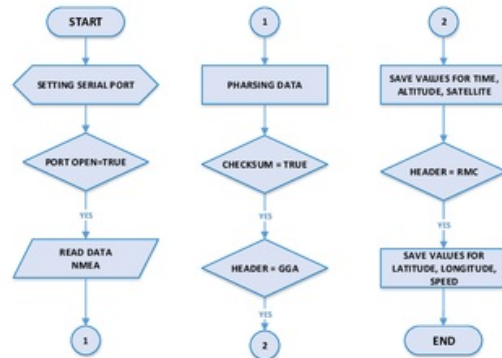

**Figure 6** Desktop Programming flowchart

**3.2 Hardware and Software Requirements**

Tables 2 and 3 will describe hardware and software requirements for the GPS system.

**Table 2** Hardware requirements

No	Hardware Type	Description
1.	AR Drone 2.0	The Drone Platform
2.	Arduino Pro Mini	Controller unit for GPS module and Drone.
3.	U-Blox NEO 6-M GPS Module	GPS module to receive data signal or communication from satellite.
4.	USB to TTL CP2102	USB interface for APC220 module.
5.	Radio Frekuensi APC220	Transceiver module (433 MHz) for receiving and sending data through radio signal between Drone and PC.
6.	Lithium Polymer Battery	7.4 volt 1000mAh Lithium Polymer Battery for GPS module system.

Tabel 3 Software requirement

No	Software Type	Version	Description
1	Arduino IDE	1.6.4	Arduino programming application.
2	U-Center	8.13	Application for testing GPS Module based on NMEA Protocol.
3	SiRF Demo	3.87	Application for testing GPS Module based on SiRF Protocol.
4	Visual Studio	2012	For making desktop application
5	AR FreeFlight	2.4.10	Android application for controlling AR Drone using smartphone.
6	Eagle CAD	6.2.0	PCB design Application

#### 4.0 IMPLEMENTATION AND TESTING

##### 4.1 Implementation

The design implementations consider the integration between GPS (Global Positioning System) and the AR Drone and the performance of sending GPS by wireless according to the procedure.

##### 4.1.1 Schematic and PCB Board Design

Schematic and PCB design are made by using EAGLE CAD version 6.2.0. Figure 7 and 8 shows the outcome.

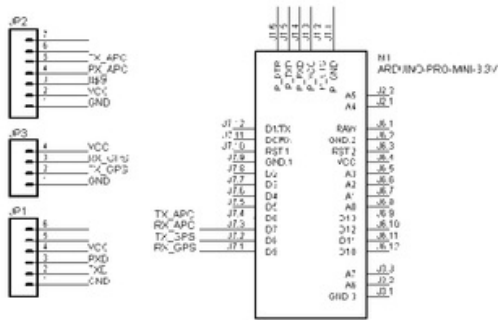

Figure 7 Schematic Design

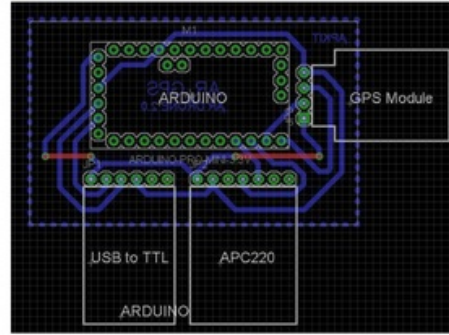

Figure 8 Desain PCB Board

##### 4.1.2 GPS Module Power Supply

The AR Drone module is power up by using its own default 11.1 and 1000 mAH battery. Unfortunately this battery could not be junction to the GPS module because it could interrupt the control system of the Drone. For this GPS Module, a 7.4 Volts, 850 mAH LITHIUM Polymer batteries is used. A regulator circuit added for regulates the voltage to 5 Volts which will be used to power up the module.

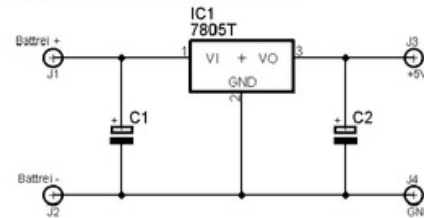

Figure 9 Regulator Schematic

##### 4.1.3 Electronics Components and Module Installation

To avoid signal interference, the GPS module could not be directly connected to the PCB board. A space needed because the noise from PCB board could interfere Satellite signal receiving. A data cable used to establish the connection between these modules. Figure 10 shows the electronics components and Module installation



Figure 10 Electronics components and Module installation

**4.1.4 Arduino Pro Mini Programming**

The Arduino Pro Mini programmed using Arduino IDE. The base language is C language. Arduino Pro Mini function is to perform data conversion from NMEA Protocol data form to SIRF Protocol data form which is the standard GPS data form of AR Drone 2.0. The data parsing method is used to do this task. Besides of this packet data conversion routine, the Arduino Pro Mini module also forward NMEA data Protocol to ground station by wireless communication. The source code for Arduino mini uploaded from PC using USB to Serial Converter interface.

**4.1.5 Frequency and Network Setting for APC220**

The frequency and network setting for APC 220 module performed by using RF-Magic for APC 22 x application programs. Figure 11 shows the setting parameters for frequency, baud rate, maximal power, Net ID and Node ID. Net ID is the identity of the network and must be set to the same value for all connecting devices in the network. Node ID is the device identity and need to set in different value for each individual device.

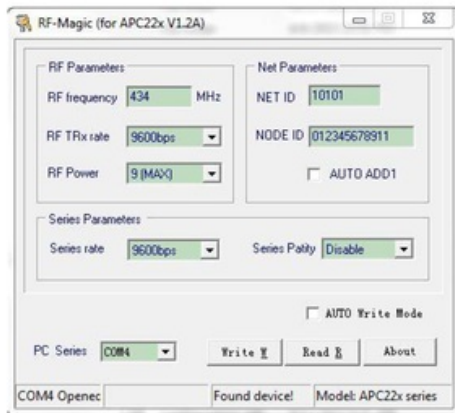

Figure 11 Setting of APC220 using RF-Magic

**4.1.5 Visual Studio Programming**

The application program that made for this system is called AR\_GPS. In this application data parsing produce information in the forms of latitude data, longitude data, altitude data, the number of connected satellites and UTC time. AR\_GPS application also functions as interface for sending data to Antenna Tracker system. With Azimuth and Elevation calculation the position direction and angle of the drone could be determined. Figure 12 shows the GUI application design of AR\_GPS. This application opens two communication ports which are communication port for GPS system and port for Antenna Tracker. It process data from GPS port and send the result to Antenna Tracker port.



Figure 12 GUI application design of AR\_GPS

**4.2 Testing Procedure**

**4.2.1 GPS Data Reading Test on PC**

The test performed by connecting GPS Module with USB TTL connected to PC. Serial Monitor function in Arduino IDE used to do the reading. This test also performed on the AR GPS application to check the program functionality. Table 4 shows the result.

Table 4 GPS data reading test results

No	NMEA Header Packet Data	Serial Monitor	AR_GPS
1	GGA	Success	Success
2	GGA	Success	Success
3	GGA	Success	Success
4	GGA	Success	Success
5	GGA	Success	Success
6	GGA	Success	Success
7	GGA	Success	Success
8	RMC	Success	Success
9	RMC	Success	Success
10	RMC	Success	Success
11	RMC	Success	Success
12	RMC	Success	Success
13	RMC	Success	Success
14	RMC	Success	Success
15	RMC	Success	Success
16	RMC	Success	Success

In Table 4, GPS data reading test shows that the GPS module could deliver the data packets and could establish connection to the satellite.

#### 4.2.2 GPS and AR Drone 2.0 Integration Test

The integration test between GPS system and AR Drone 2.0 performs by connecting GPS system to AR Drone 2.0 using USB Extended from AR Drone for data communication with the extender devices. The AR Free Flight application on Smartphone is used to see the GPS connection status with the satellite.

**Table 5** GPS and AR Drone integration test data

No	Integration Test	AR FreeFlight Result
1	Test 1	GPS Detected
2	Test 2	GPS Detected
3	Test 3	GPS Detected
4	Test 4	GPS Detected
5	Test 5	GPS Detected

The detection of GPS in Table 5 also indicate that data packets that been transmitted from GPS has been accepted by the AR Drone.

#### 4.2.3 Wireless data Transmitting Test

Wireless data transmitting test performs by connecting APC220 module to PC and Arduino board. Several text data send from PC to controller to see whether APC220 could send and received the data. Table 6 shows the wireless data delivery test.

**Table 6** Wireless Data Delivery Test

No	Data Send	Data Received	Result
1	TEST!	TEST!	Success
2	Halo?	Halo?	Success
3	ABCDEFGHIJ	ABCDEFGHIJ	Success
4	FF05DEA7	FF05DEA7	Success
5	\$GGA,\$RMC	\$GGA,\$RMC	Success

Test results show that APC220 module could send data via wireless.

#### 4.2.4 AR Drone 2.0 Hold Position Test

*Hold Position* test performs by installing the GPS Module to the drone and do the fly action. Table 7 shows the Hold Position test. The GPS to satellite connection status need to be checked before it flown. After the Drone sets on the air, the drone control flight is set to stay in normal position to see whether the drone could maintain its position or will be moved by the wind force. Test result shows that the Drone could maintain its Hold position well even in a windy environment.

**Table 7** Hold Position test

No	Action to change Drone position	Reaksi Drone
1	<i>Pull the Drone</i>	Move back to its position
2	<i>Push the Drone</i>	Move back to its position
3	<i>Do nothing to Drone</i>	Maintain its position
4	<i>Apply winds to Drone</i>	Maintain its position

#### 4.2.5 Way Point Test Using AR Free Flight

*Way Point* test performs by flying the AR Drone to the coordinate point on the map. The AR Drone should be connected to GPS Module and satellite connection should be established first. AR Free Flight application used to give the task to the drone and check whether drone will automatically fly to the destination point.

**Table 8** Way Point test

No	Way Point	Result
1	Way Point 1	Success
2	Way Point 2	Success
3	Way Point 3	Success
4	Way Point 4	Success
5	Way Point 5	Success

Table 8 demonstrates the Way Point test. The drones can fly automatically or doing auto pilot actions to the determined coordinates.

## 5.0 CONCLUSION

Test data can be concluded as follows:

1. The GPS module is able to transmit data to PC in the form of data packets NMEA protocol, so the GPS module can function properly in the term of data transmission.
2. The AR Drone 2.0 could accept data transmitted from GPS system by the indication of GPS version status and the number of satellites connected with the AR Drone at Free flight AR application. The position of AR Drone could also be read by the map facility of the free flight AR application.
3. Test data shows that the wireless radio frequency communication could function as transceiver because it could transmit and receive data well.
4. The AR Drone 2.0 could perform its *Hold position* action well which indicate its ability to fly or used in fairly strong windy environment.
5. AR Drone could do *way point*, which means it could fly automatically to the coordinates determined by the GPS.

## References

- [1] Pankaj Verma, J. S Bhatia. 2013. Design and Development of GPS-GSM Based Tracking System with Google Map Based Monitoring. *International Journal of Computer Science, Engineering and Application (IJCSEA)*. 3(3).
- [2] B. W. Parkinson and S. W. Gilbert. 1993. Navstar: Global Positioning System-Ten Years Later. *Proceedings of the IEEE*. 71(10): 1177-1186.
- [3] Parrot, A. R. Drone 2.0 Review: Fly Higher, Farther, and More Intuitively. [Online]. Hyperlink: <http://www.popsci.com.au/gadgets/parrot-ardrone-20-review-fly-higher-farther-and-more-intuitively,377972>.
- [4] Technical Specifications State. Of art Technology. <http://ardrone2.parrot.com/ardrone-2/specifications/>.
- [5] Banzi Massimo. 2009. *Getting Started With Arduino*. MakeBooks Publishing.
- [6] ARDUINO. ARDUINO PRO MINI: Overview, Summary [Online]. Hyperlink: <http://arduino.cc/en/Main/ArduinoBoardProMini>.
- [7] U-BLOX: NEO 6 U-blox 6 GPS Modules Datasheet. [ONLINE]. Hyperlink: [http://www.u-blox.de/images/downloads/Product\\_Docs/NEO-6\\_DataSheet\\_\(GPS.G6-HW-09005\).pdf](http://www.u-blox.de/images/downloads/Product_Docs/NEO-6_DataSheet_(GPS.G6-HW-09005).pdf).
- [8] SiRF. 2005. *NMEA Reference Manual*. California: Sir F Technology, Inc.



# TRANSMITTING GPS AS TEXT FORM THROUGH WIRELESS ON DRONE 2.0

---

ORIGINALITY REPORT

---

# 10%

SIMILARITY INDEX

---

MATCH ALL SOURCES (ONLY SELECTED SOURCE PRINTED)

---

★d1.ourdev.cn

Internet

2%

---

EXCLUDE QUOTES ON

EXCLUDE MATCHES OFF

EXCLUDE BIBLIOGRAPHY ON